

NPN EPITAXIAL PLANAR TRANSISTOR

(Pb) Lead(Pb)-Free

Features:

- * Large current capacitance
- * Low collector-to-emitter saturation voltage
- * High-speed switching
- * High allowable dissipation

Mechanical Data:

- * Case : Molded Plastic
- * Weight : 0.925 grams

1.BASE
2.COLLECTOR
3.EMITTER

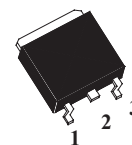

D-PAK(TO-252)

ABSOLUTE MAXIMUM RATINGS(Ta=25°C)

Rating	Symbol	Value	Unit
Collector to Base Voltage	V _{CBO}	80	V
Collector to Emitter Voltage	V _{CES}	80	V
Collector to Emitter Voltage	V _{CEO}	50	V
Collector to Base Voltage	V _{EBO}	6	V
Collector Current	I _C (DC)	5	A
	I _C (Pulse)	7.5	
Base Current	I _B	1.2	A
Total Device Dissipation	P _D	T _A = 25°C	0.8
		T _C = 25°C	15
Junction Temperature	T _J	+150	°C
Storage Temperature	T _{stg}	-55 to +150	°C

Device Marking

2SC5706 = 5706

ELECTRICAL CHARACTERISTICS

Characteristics	Symbol	Min	Max	Max	Unit
Collector-Base Breakdown Voltage $I_C=10\mu A, I_E=0$	BV_{CBO}	80	-	-	V
Collector-Emitter Breakdown Voltage $I_C=100\mu A, R_{BE}=0$	BV_{CES}	80	-	-	V
Collector-Emitter Breakdown Voltage $I_C=1mA, R_{BE}=\infty$	BV_{CEO}	50	-	-	V
Emitter-Base Breakdown Voltage $I_E=10\mu A, I_C=0$	BV_{EBO}	6	-	-	V
Collector Cut-Off Current $V_{CB}=40V, I_E=0$	I_{CBO}	-	-	1	μA
Emitter-Cut-Off Current $V_{EB}=4V, I_C=0$	I_{EBO}	-	-	1	μA

ON CHARACTERISTICS⁽¹⁾

DC Current Gain $V_{CE}=2V, I_C=500mA$	h_{FE}	200	-	560	-
Collector-Emitter Saturation Voltage $I_C=1A, I_B=50mA$ $I_C=2A, I_B=100mA$	$V_{CE(sat)}$	-	-	135 240	mV
Base-Emitter Saturation Voltage $I_C=2A, I_B=100mA$	$V_{BE(sat)}$	-	-	1.2	V

Note 1. Pulse Test : Pulse width < 300 μs , Duty cycle \leq 20%.

DYNAMIC CHARACTERISTICS

Transition Frequency $V_{CE}=10V, I_C=500$	f_T	-	400	-	MHz
Output Capacitance $V_{CB}=10V, f=1MHz$	C_{ob}	-	15	-	pF

SWITCHING TIMES

See specified test circuit (Turn-On Time)	t_{on}	-	35	-	ns
See specified test circuit (Storage Time)	t_{stg}	-	300	-	
See specified test circuit (Fall Time)	t_f	-	20	-	

Switching Time Test Circuit

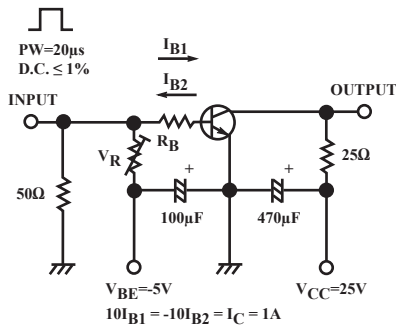

Characteristics Curve

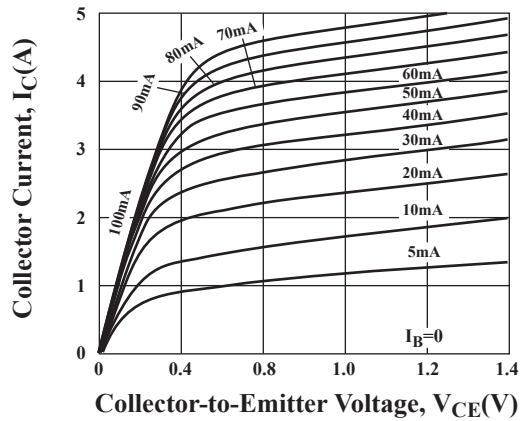

FIG.1 $I_C - V_{CE}$

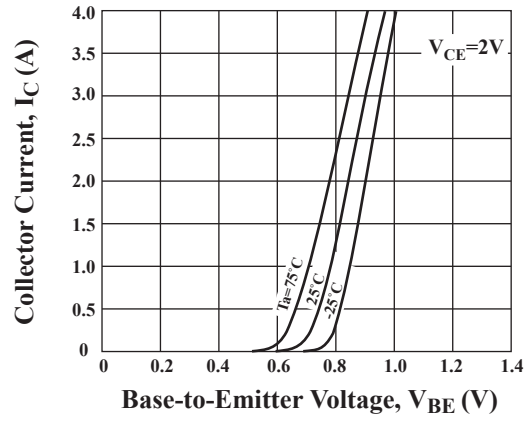

FIG.2 $I_C - V_{BE}$

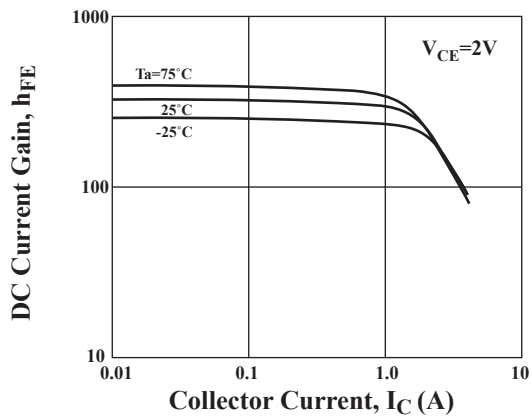

FIG.3 $h_{FE} - I_C$

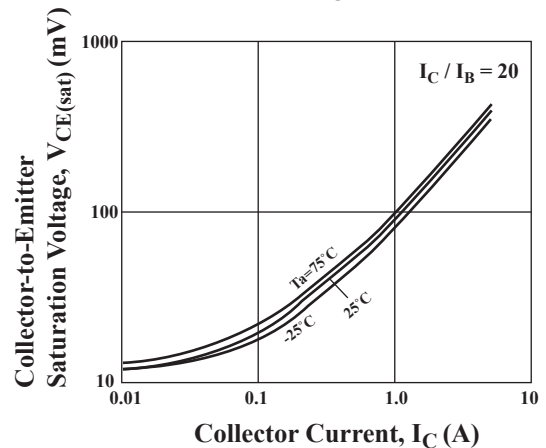

FIG.4 $V_{CE(sat)} - I_C$

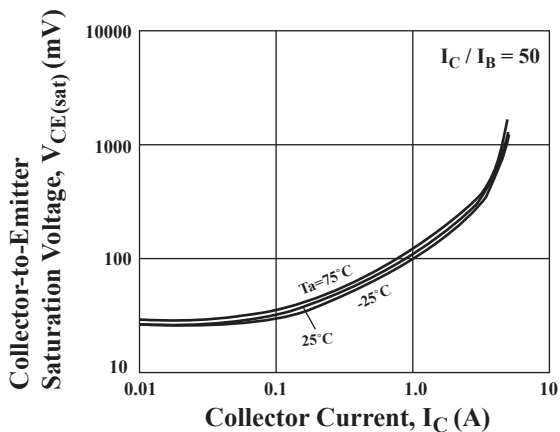

FIG.5 $V_{CE(sat)} - I_C$

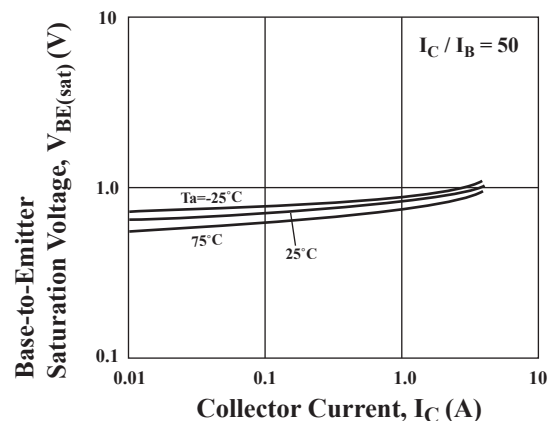

FIG.6 $V_{BE(sat)} - I_C$

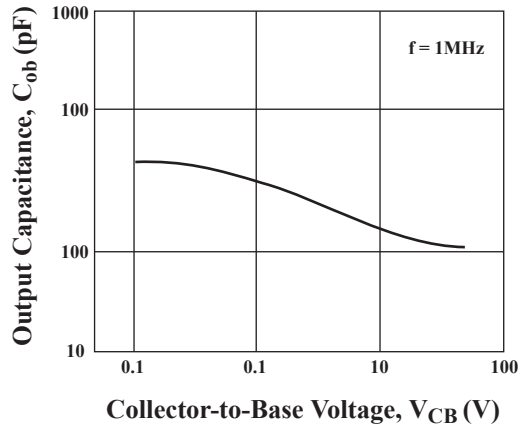

FIG.7 $C_{ob} - V_{CB}$

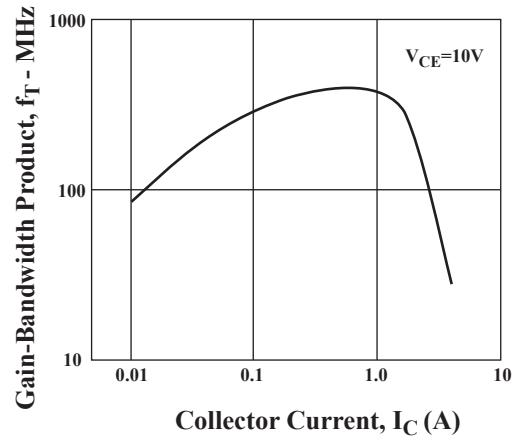

FIG.8 $f_T - I_C$

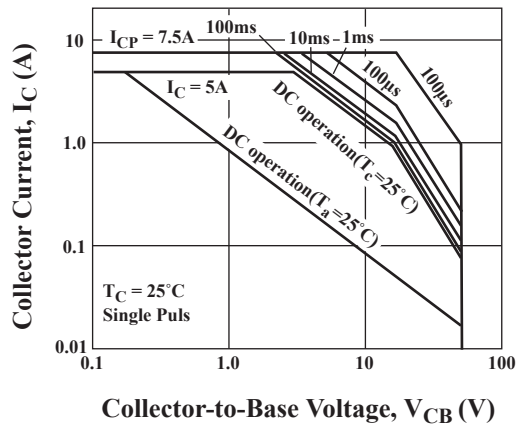

FIG.9 ASO

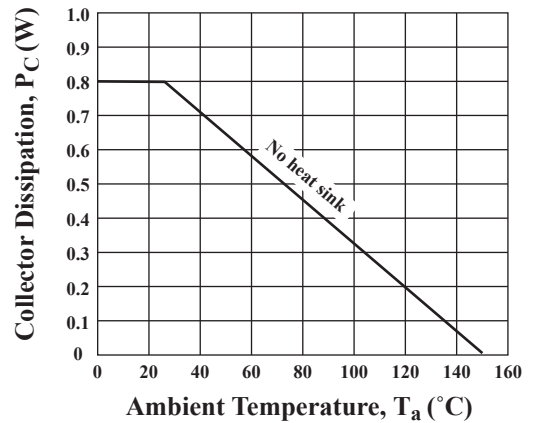

FIG.9 $P_C - T_a$

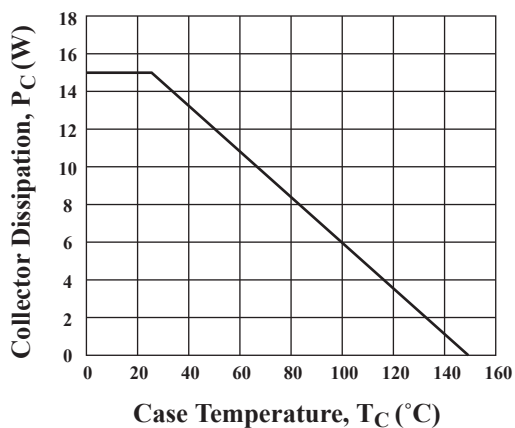
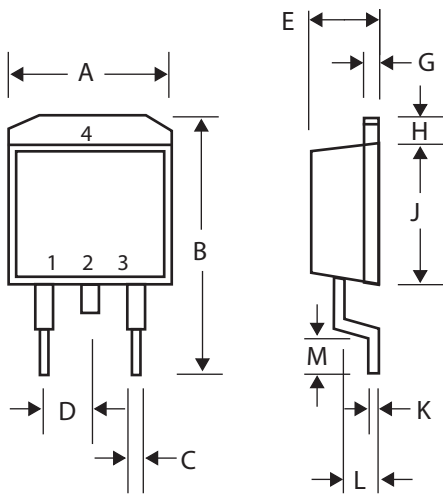

FIG.10 $P_C - T_C$

D-PAK Outline Dimensions

unit:mm

D-PAK(TO-252)



D-PAK		
Dim	Min	Max
A	6.40	6.80
B	9.00	10.00
C	0.50	0.80
D	-	2.30
E	2.20	2.50
G	0.45	0.55
H	1.00	1.60
J	5.40	5.80
K	0.30	0.64
L	0.70	1.70
M	0.90	1.50