

SWITCHMODE SERIES NPN POWER TRANSISTORS

... designed for use in high-voltage, high-speed, power switching in inductive circuit, they are particularly suited for 115 and 220 V switchmode applications such as switching regulator's, inverters, DC -DC conveter, Motor Controls, Solenoid drive and Deflection circuits.

FEATURES:

*Collector-Emitter Sustaining Voltage-

$$V_{CE(sus)} = 400 \text{ V and } 300 \text{ V}$$

* Collector-Emitter Saturation Voltage -

$$V_{CE(sat)} = 3.0 \text{ V (Max.) @ } I_C = 8.0 \text{ A, } I_B = 2.0 \text{ A}$$

* Switching Time - $t_f = 0.7 \text{ us (Max.) @ } I_C = 5.0 \text{ A}$

* SOA and Switching Application Information.

NPN
MJE13006
MJE13007

8 AMPERE
POWER
TRANSISTORS
300-400 VOLTS
80 WATTS

MAXIMUM RATINGS

Characteristic	Symbol	MJE13006	MJE13007	Unit
Collector-Emitter Voltage	V_{CEO}	300	400	V
Collector-Emitter Voltage	V_{CEV}	600	700	V
Emitter-Base Voltage	V_{EBO}	9		V
Collector Current - Continuous	I_C	8		A
Collector Current - Peak	I_{CM}	16		A
Base current	I_B	4		A
Total Power Dissipation @ $T_C = 25^\circ\text{C}$ Derate above 25°C	P_D	80	640	W mW/°C
Operating and Storage Junction Temperature Range	T_J, T_{STG}	-65 to +150		°C

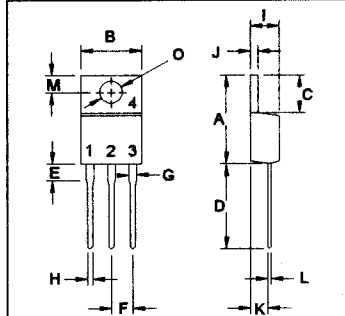
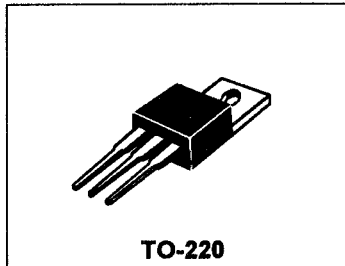

PIN 1.BASE
2.COLLECTOR
3.EMITTER
4.COLLECTOR(CASE)

THERMAL CHARACTERISTICS

Characteristic	Symbol	Max	Unit
Thermal Resistance Junction to Case	$R_{\theta jc}$	1.56	°C/W

DIM	MILLIMETERS	
	MIN	MAX
A	14.68	15.31
B	9.78	10.42
C	5.01	6.52
D	13.06	14.62
E	3.57	4.07
F	2.42	3.66
G	1.12	1.36
H	0.72	0.96
I	4.22	4.98
J	1.14	1.38
K	2.20	2.97
L	0.33	0.55
M	2.48	2.98
O	3.70	3.90

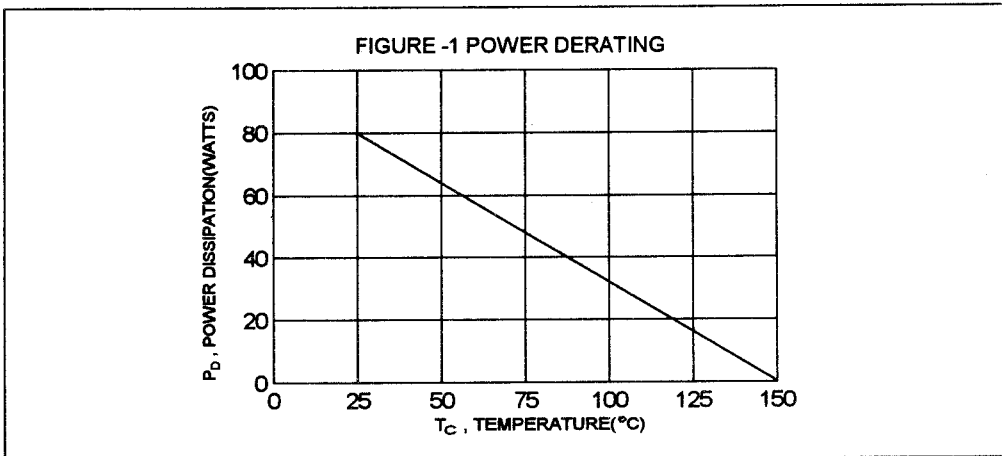

ELECTRICAL CHARACTERISTICS ($T_c = 25^\circ\text{C}$ unless otherwise noted)

Characteristic	Symbol	Min	Max	Unit
----------------	--------	-----	-----	------

OFF CHARACTERISTICS

Collector-Emitter Sustaining Voltage ($I_C = 10\text{ mA}, I_B = 0$) MJE13006 MJE13007	$V_{CEO(sus)}$	300 400		V
Collector Cutoff Current ($V_{CEV} = \text{Rated Value}, V_{BE(off)} = 1.5\text{ V}$) ($V_{CEV} = \text{Rated Value}, V_{BE(off)} = 1.5\text{ V}, T_c = 100^\circ\text{C}$)	I_{CEV}		1.0 5.0	mA
Emitter Cutoff Current ($V_{EB} = 9.0\text{ V}, I_C = 0$)	I_{EBO}		1.0	mA

ON CHARACTERISTICS (1)

DC Current Gain ($I_C = 2.0\text{ A}, V_{CE} = 5.0\text{ V}$) ($I_C = 5.0\text{ A}, V_{CE} = 5.0\text{ V}$)	hFE	8.0 5.0	60 30	
Collector-Emitter Saturation Voltage ($I_C = 2.0\text{ A}, I_B = 400\text{ mA}$) ($I_C = 5.0\text{ A}, I_B = 1.0\text{ A}$) ($I_C = 8.0\text{ A}, I_B = 2.0\text{ A}$)	$V_{CE(sat)}$		1.0 2.0 3.0	V
Base-Emitter Saturation Voltage ($I_C = 2.0\text{ A}, I_B = 400\text{ mA}$) ($I_C = 5.0\text{ A}, I_B = 1.0\text{ A}$)	$V_{BE(sat)}$		1.2 1.6	V

DYNAMIC CHARACTERISTICS

Current Gain - Bandwidth Product ($I_C = 500\text{ mA}, V_{CE} = 10\text{ V}, f = 1.0\text{ MHz}$)	f_T	4.0		MHz
Output Capacitance ($V_{CB} = 10\text{ V}, I_E = 0, f = 0.1\text{ MHz}$)	C_{ob}	110(typ)		pF

SWITCHING CHARACTERISTICS

Delay Time	$V_{CC} = 125\text{ V}, I_C = 5.0\text{ A}$ $I_{B1} = -I_{B2} = 1.0\text{ A}$ $t_p = 25\text{ us}, \text{Duty Cycle} \leq 1.0\%$	t_d	0.1	us
Rise Time		t_r	1.5	us
Storage Time		t_s	3.0	us
Fall Time		t_f	0.7	us

(1) Pulse Test: Pulse Width = 300 us, Duty Cycle $\leq 2.0\%$

DC CURRENT GAIN

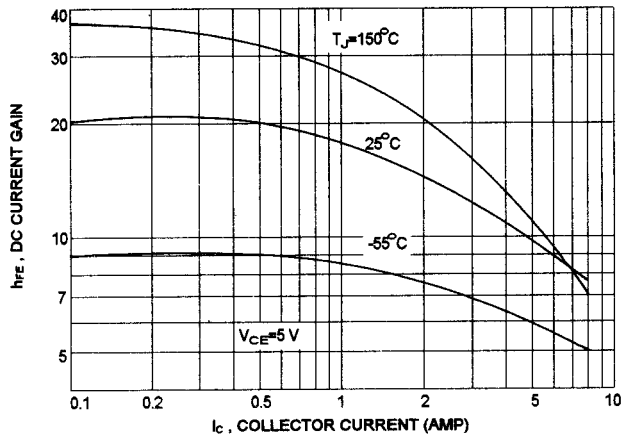

COLLECTOR SATURATION REGION

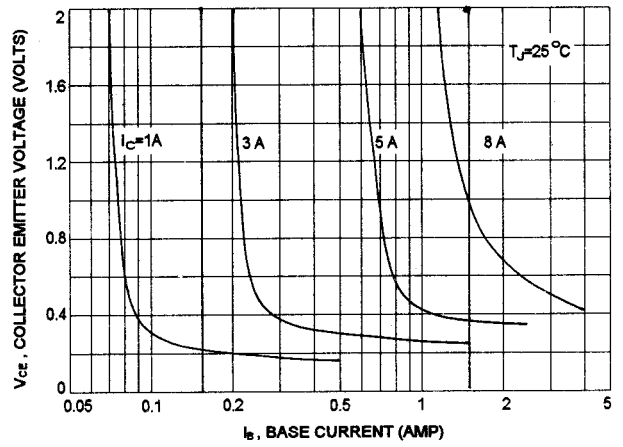

BASE-EMITTER SATURATION VOLTAGE

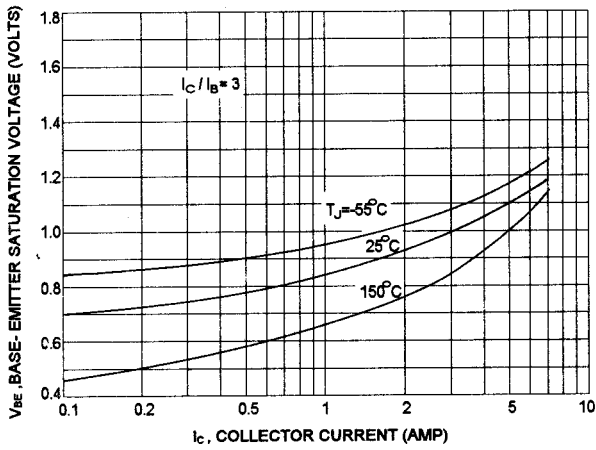

COLLECTOR-EMITTER SATURATION VOLTAGE

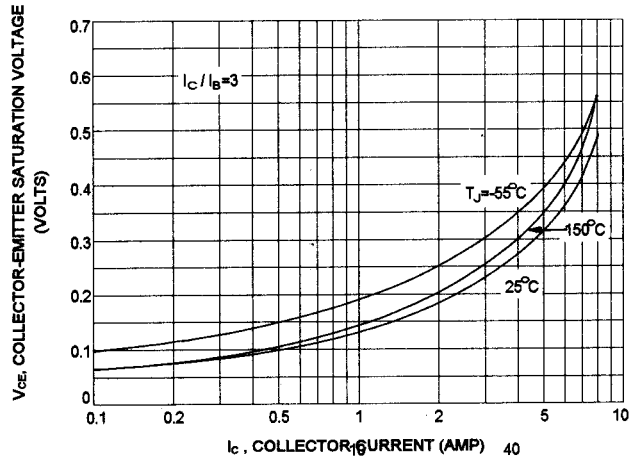

COLLECTOR CUT-OFF REGION

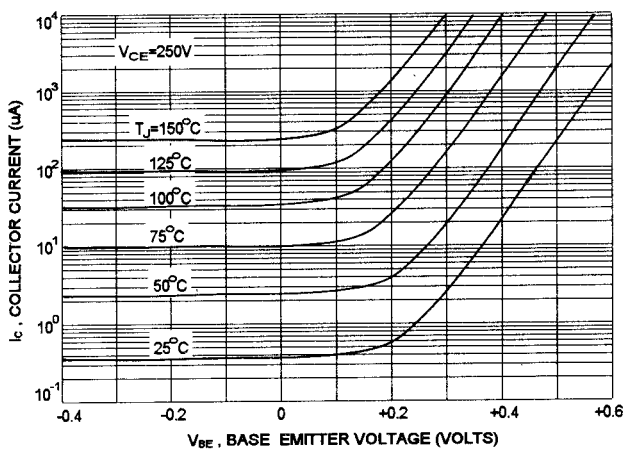

CAPACITANCE

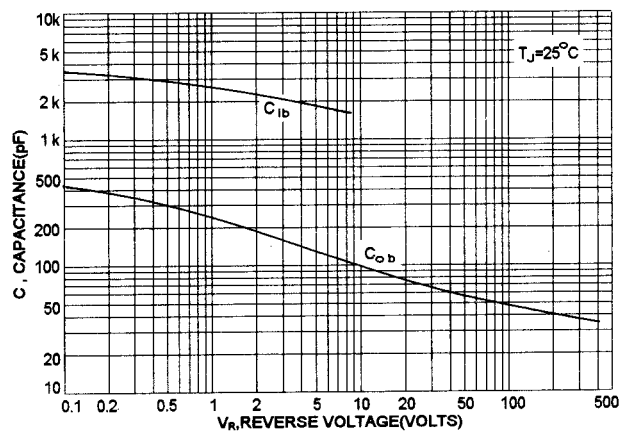

TURN-ON TIME

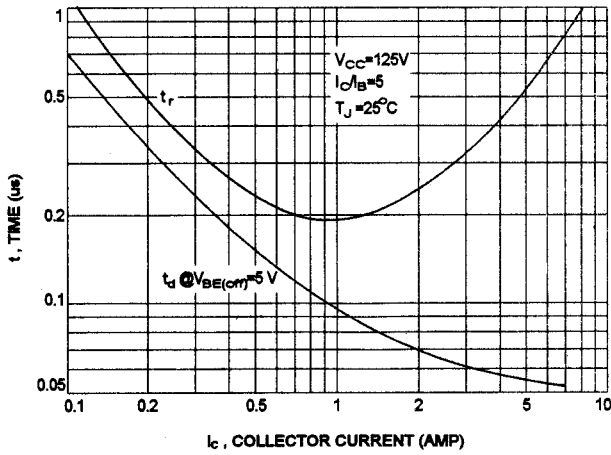

TURN-OFF TIME

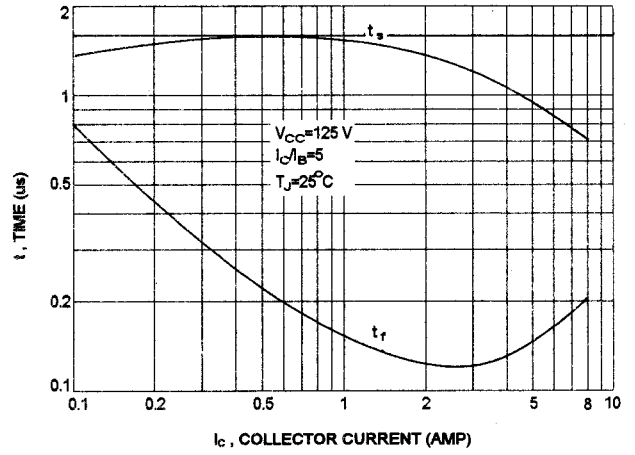

ACTIVE REGION SAFE OPERATING AREA

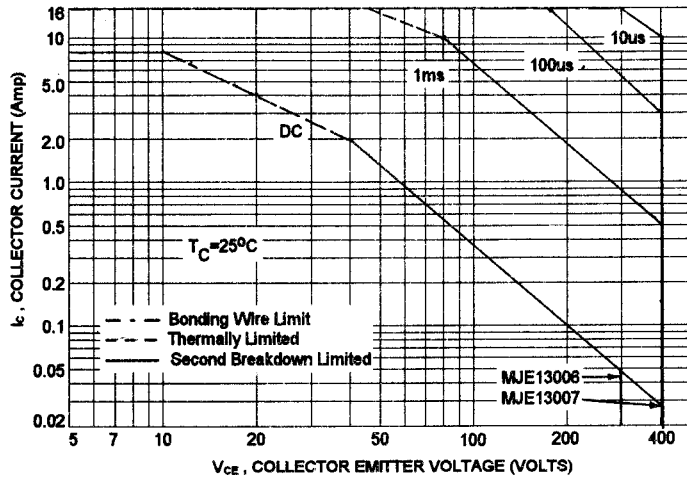

REVERSE BIAS SWITCHING SAFE OPERATING AREA

